

Wiesbaden 34 (485x380)

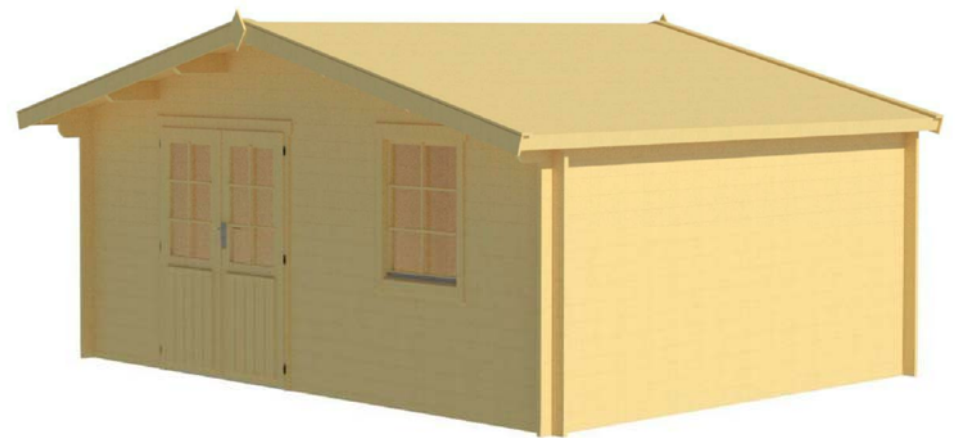

Wiesbaden 34 (485x380)

Wall 1

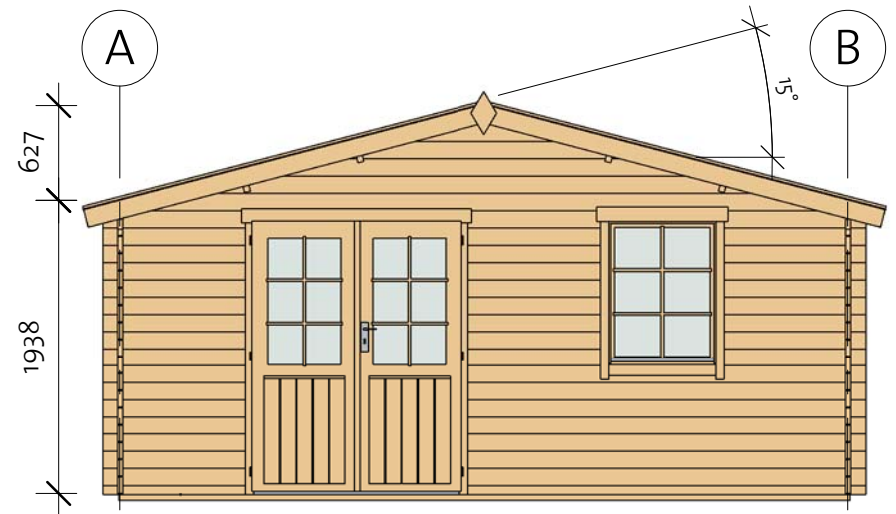
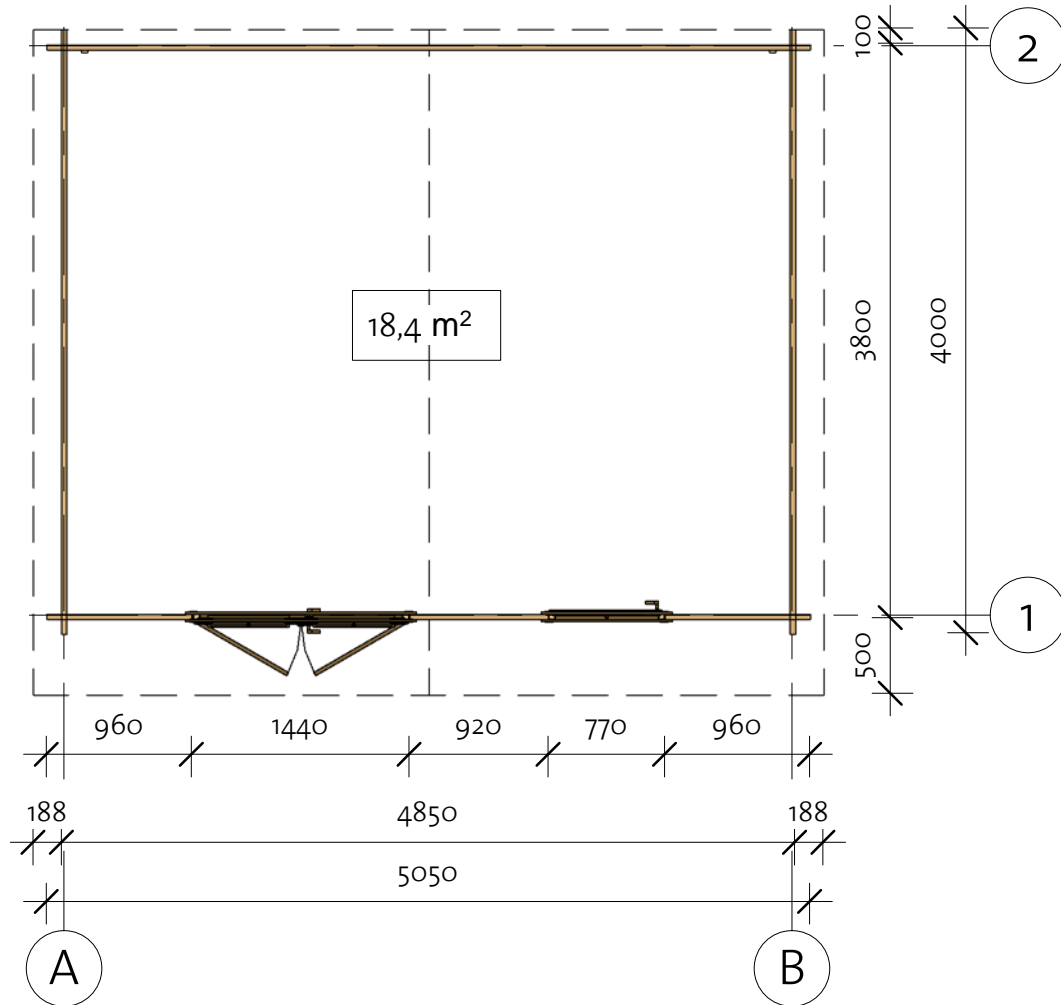
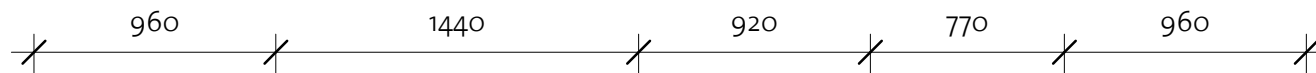
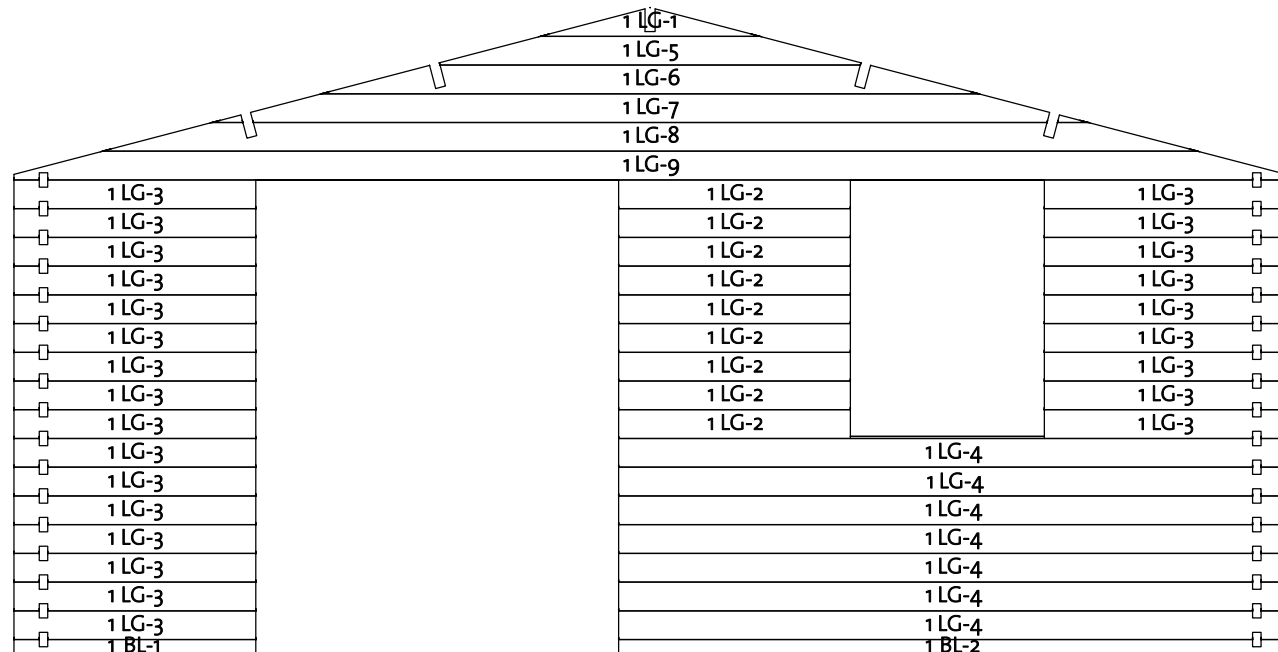

Wall 1			
Mark	Profile	Count	Cut Length

1BL-1	34x57	1	960
1BL-2	34x57	1	2650
1LG-1*	34x114	1	870
1LG-2	34x114	9	920
1LG-3	34x114	25	960
1LG-4	34x114	7	2650
1LG-5*	34x114	1	1673
1LG-6*	34x114	1	2609
1LG-7*	34x114	1	3478
1LG-8*	34x114	1	4347
1LG-9*	34x114	1	5050

* Gable - delivered premounted

Log Profile Wall 1	
Profile	Profile

34x57	
34x114	

Wiesbaden 34 (485x380)

Wall 2

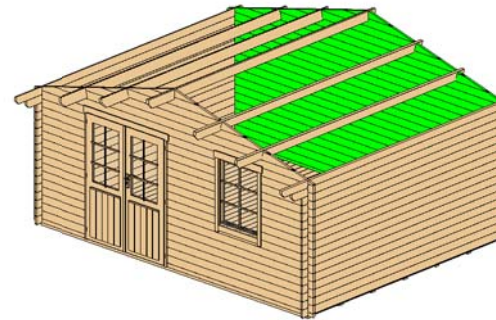



Wall 2			
Mark	Profile	Count	Cut Length

2BL-1	34x57	1	5050
2LG-1*	34x114	1	870
2LG-2*	34x114	1	1673
2LG-3*	34x114	1	2609
2LG-4*	34x114	1	3478
2LG-5*	34x114	1	4347
2LG-6	34x114	16	5050
2LG-7*	34x114	1	5050

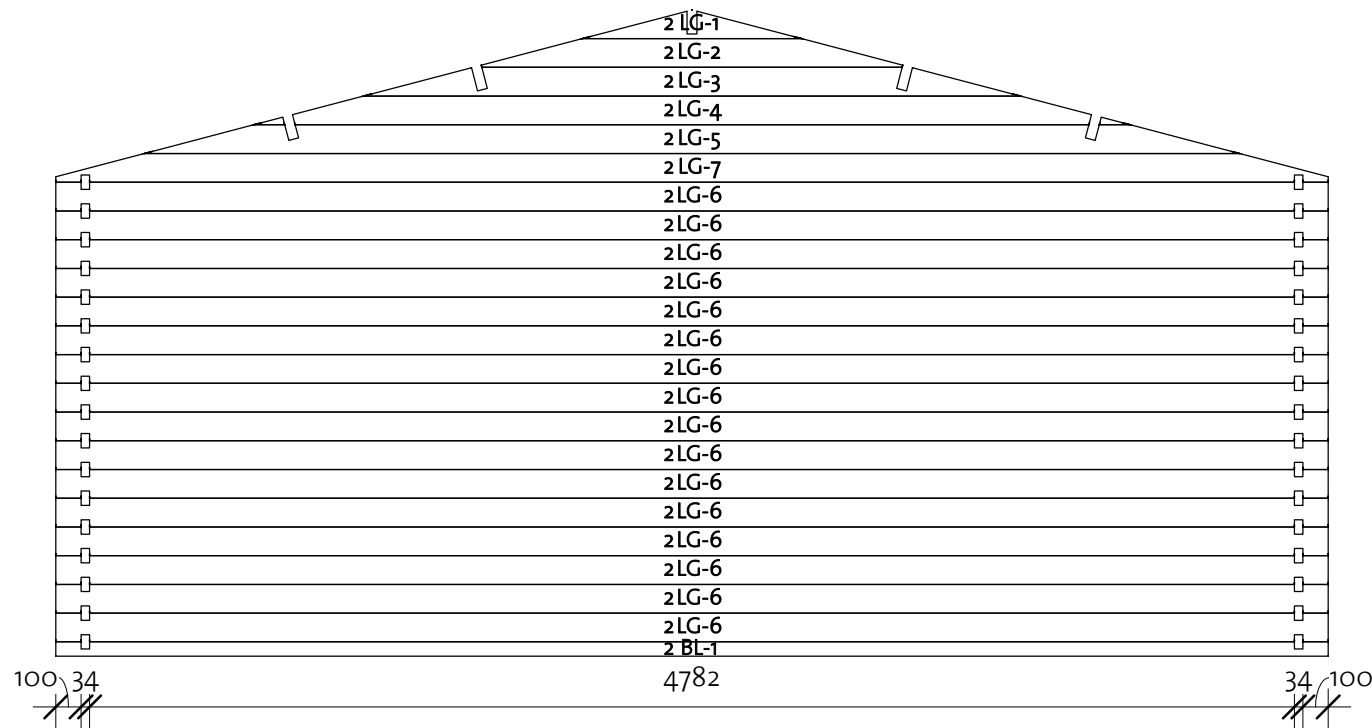
* Gable - delivered premounted



Log Profile Wall 2	
Profile	Profile

34x57	
34x114	

Wiesbaden 34 (485x380)

Wall A

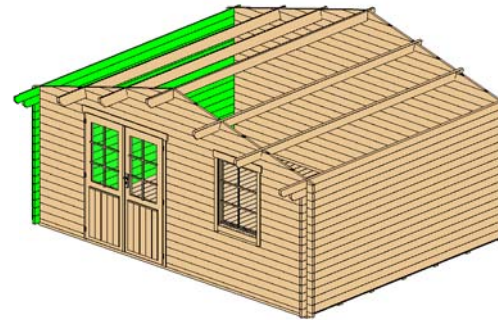

Wall A			
Mark	Profile	Count	Cut Length

ALG-1	34X114	15	4000
ALG-2	34X114	1	4200
ATL-1	34X114	1	4400

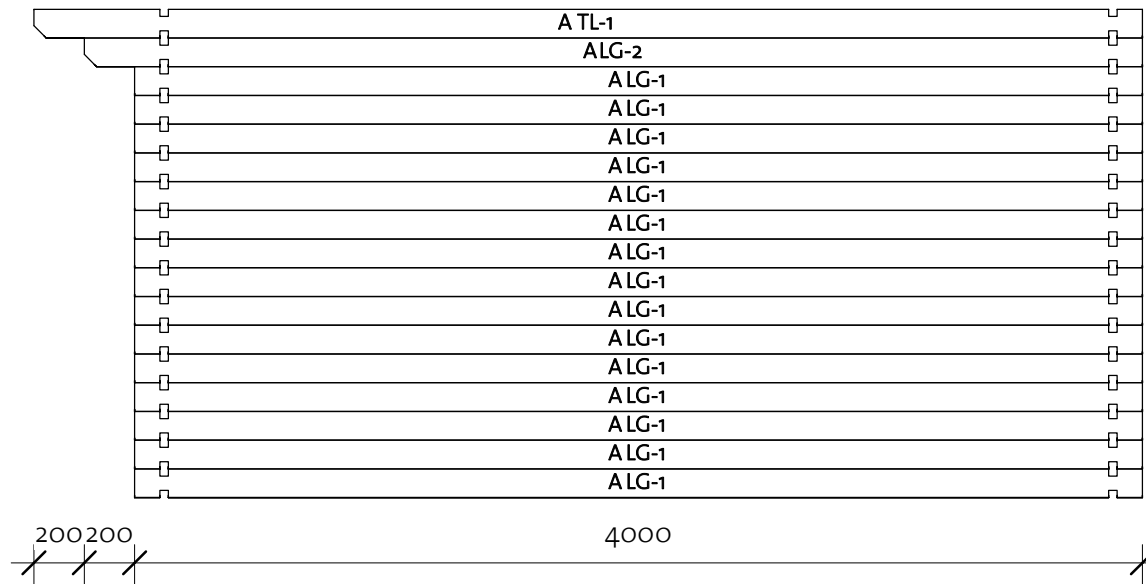

Log Profile Wall A	
Profile	Profile

34X114	
34X114	

Wiesbaden 34 (485x380)

Wall B

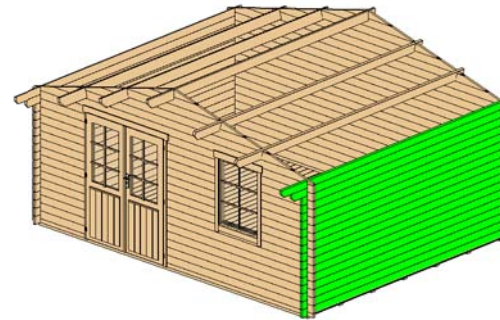

Wall B			
Mark	Profile	Count	Cut Length

BLG-1	34X114	15	4000
BLG-2	34X114	1	4200
BTL-1	34X114	1	4400

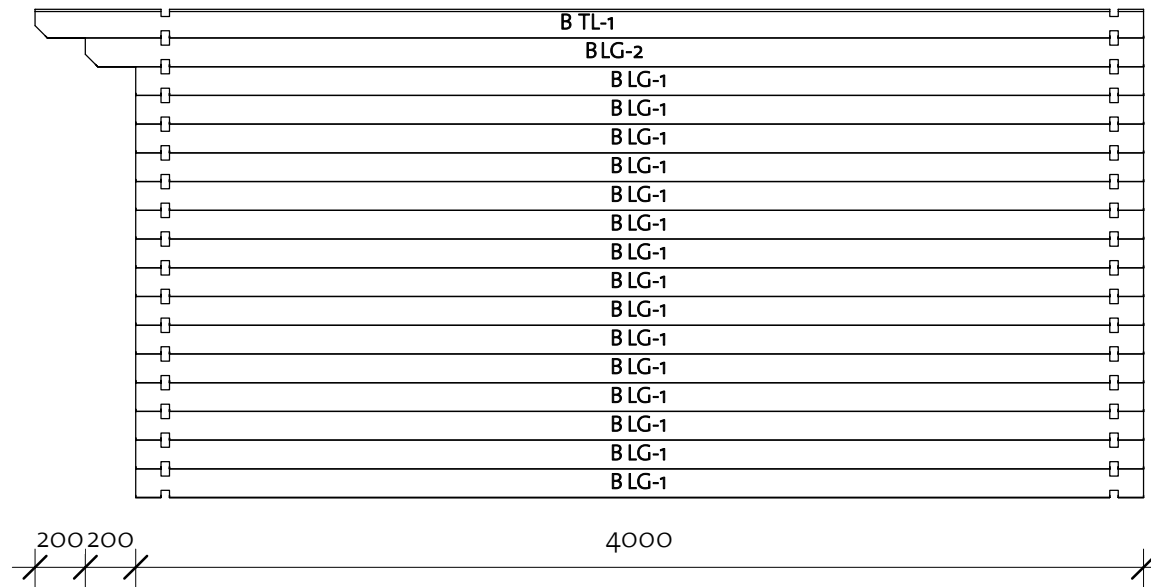





Log Profile Wall B	
Profile	Profile

34X114	
34X114	

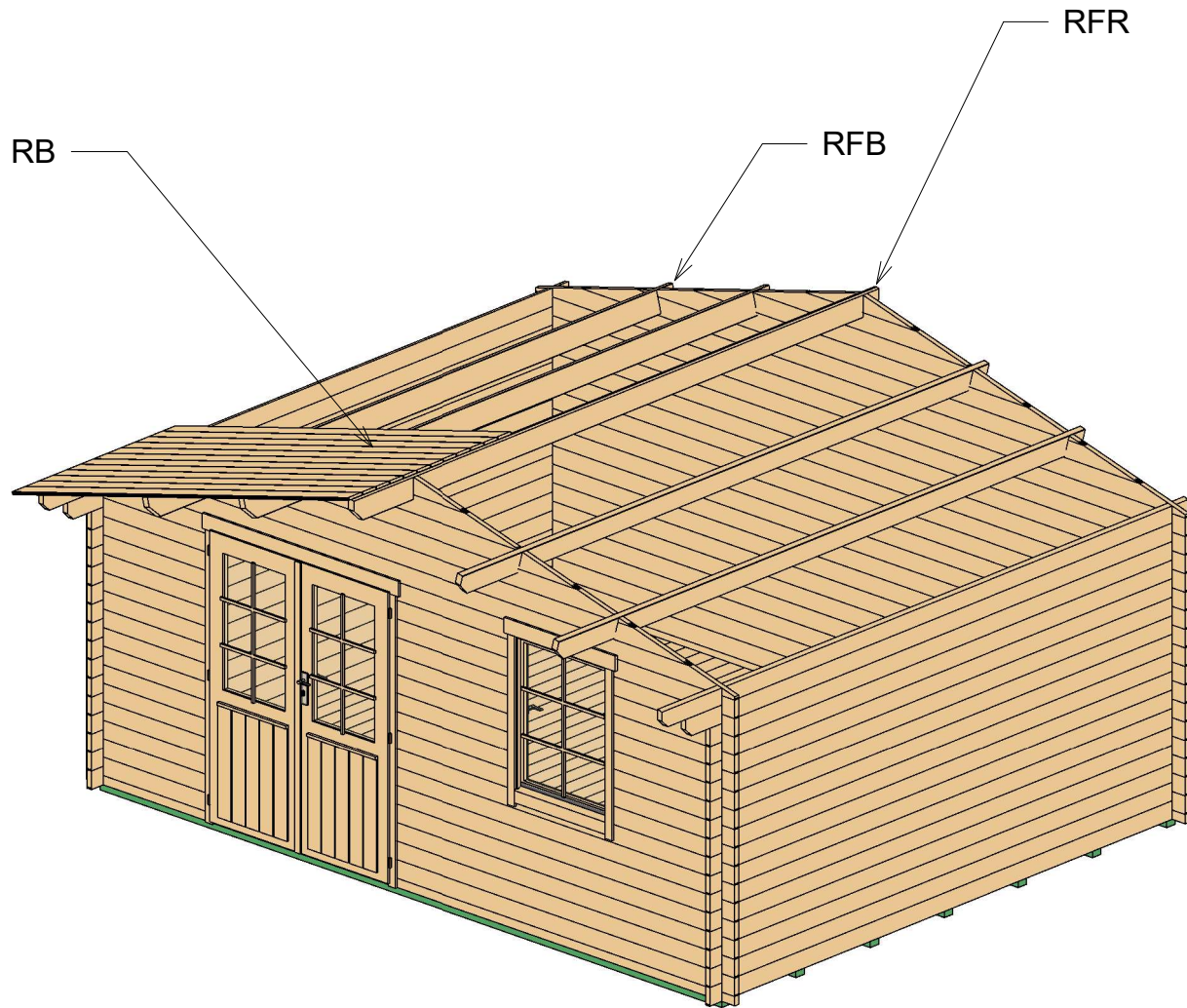
Wiesbaden 34 (485x380)

Roof 1



Roof				
Mark	Type	Profile	Count	Length
RFR	Ridge 40X143		1	4400
RFB	Beam 40X143		4	4400
RB	17X114		80	2697

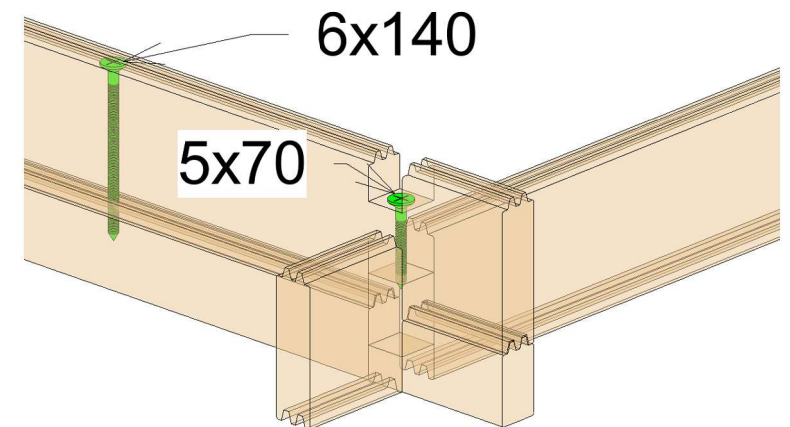

Screws only in first 2 rows

Wiesbaden 34 (485x380)

Roof 2

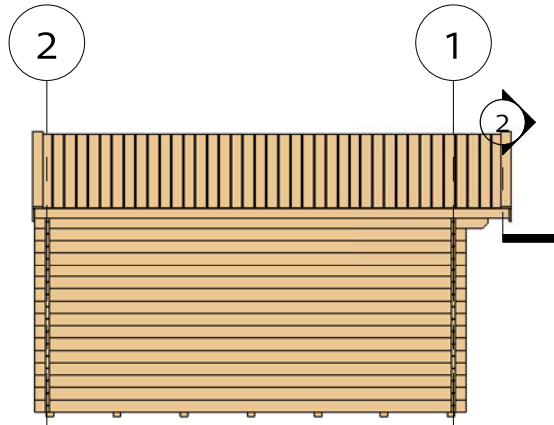

② Facia

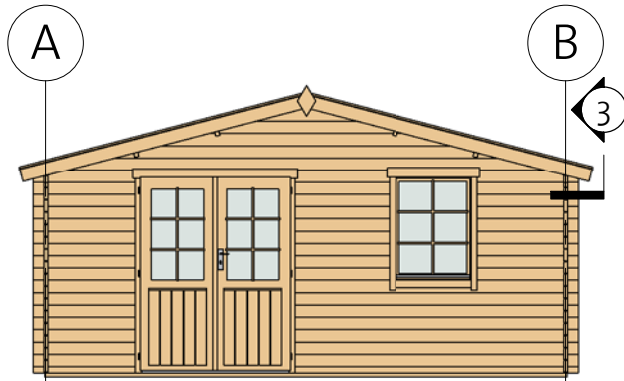
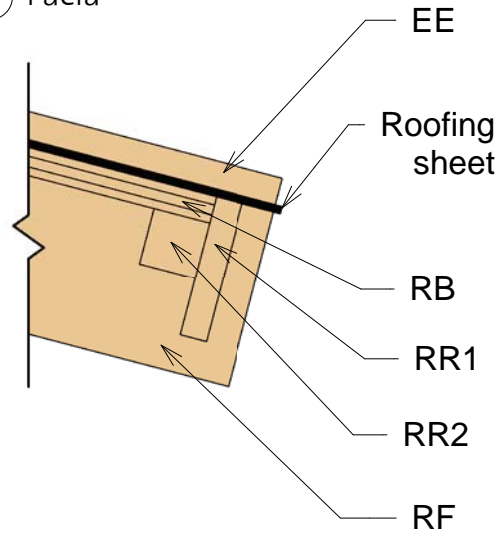

③ Roof Reinforcement

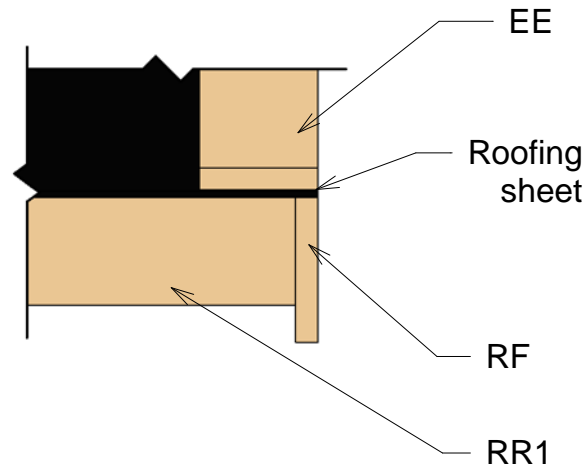











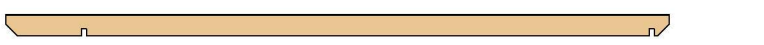



Fascia Schedule

Mark	Type	Profile	Count	Length
EE	Eave Edging 18x95		4	2741
RF	Roof Fascia 18x120		4	2741
RR1	Roof reinforcement 18x95		2	4400
RR2	Roof reinforcement 38x38		2	4400

Wiesbaden 34 (485x380)

List of all items 1



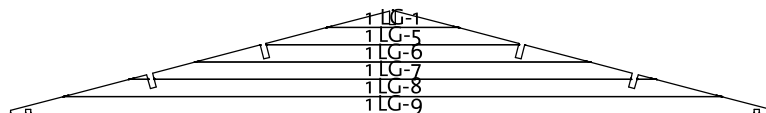

2	BL-1	HalfLog 34x57		1	5050
2	LG-6	Log 34x114		16	5050
	RFB	Beam 40x143		4	4400
	RFR	Ridge 40x143		1	4400
A	TL-1	Log 34x114		1	4400
B	TL-1	Log 34x114		1	4400
A	LG-2	Log 34x114		1	4200
B	LG-2	Log 34x114		1	4200
A	LG-1	Log 34x114		15	4000
B	LG-1	Log 34x114		15	4000
	RB	17x114		80	2697
1	BL-2	HalfLog 34x57		1	2650
1	LG-4	Log 34x114		7	2650
1	BL-1	HalfLog 34x57		1	960
1	LG-3	Log 34x114		25	960
1	LG-2	Log 34x114		9	920

① Gable 1

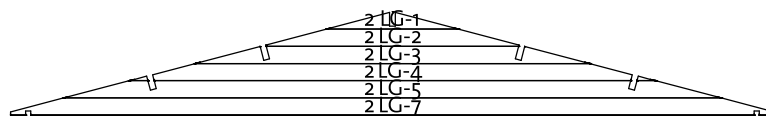

② Gable 2



RR1	Roof reinforce- ment 18x95		2	4400
RR2	Roof reinforce- ment 38x38		2	4400
EE	Eave Edging 18x95		4	2741
RF	Roof Fascia 18x120		4	2741

Wiesbaden 34 (485x380)

List of all items 2

Windboard 18x40		4	2200
--------------------	---	---	------

B34DD1R	Basic 34 double door 1 right	1425	1835		1
---------	------------------------------------	------	------	---	---



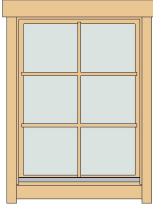



DCB6	Door Crossbar 6	--	--		2
------	--------------------	----	----	--	---

B34W2L	Basic 34 window 2 left	765	990		1
--------	------------------------------	-----	-----	--	---

WCB6	Windows Crossbar 6	--	--		1
------	-----------------------	----	----	--	---

Romb	2
------	---



Hitblock	300-400 mm		
Bolts	M8x70		12
Screws	5,0 x 70		15
Screws	6,0 x 140		20
Screws	4,0 x 40		90
Screws	4,0 x 50		350